

DESCRIPTION

PMF2000 features Posifa's third-generation thermal flow die, benefiting from the latest innovations in microfabrication. The sensor die uses a pair of thermopiles to detect changes in temperature gradient caused by mass flow, delivering excellent signal-to-noise, and repeatability. The "solid state" thermal isolation structure on the sensor die eliminates the need for surface cavity or fragile membrane used in competing technologies, making the sensor resistant to clogging and pressure shock.

The PMF2000 series includes the analog output PMF2000V and the digital I²C output PMF2000D.

The supported max flow rate ranges from 200 sccm to 10 SLM. The sensors are temperature compensated over the temperature range of 0 to 50 °C. The linearized output provides maximum flexibility and ease-of-use.

APPLICATIONS

- Oxygen concentrators
- Nebulizers
- CPAP equipment
- Leak detection
- Spectroscopy
- Mass flow controller
- Fuel cell control
- Environmental monitoring

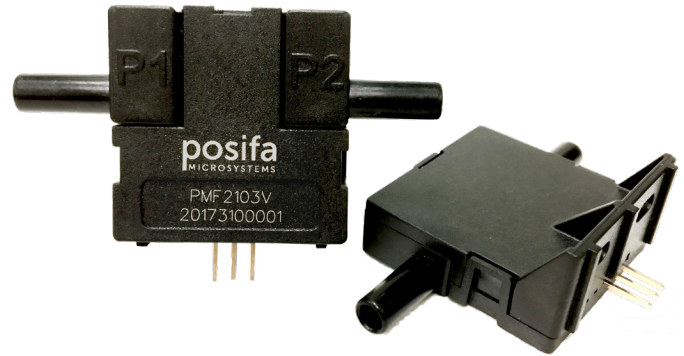

FEATURES

- Unsurpassed performance in a robust and cost effective package
- "Solid state" sensing core (no surface cavity or fragile membrane) resistant to clogging and pressure shock
- Highly accurate (4% reading typ.)
- Fast response time (5 ms typ.)
- Linear output and temperature compensation
- Long-term stability with minimal null drift

MAXIMUM RATINGS

- Operating Temperature: -25 to 85 °C
- Calibrated Temperature Range: 0 to 50 °C
- Storage Temperature: -40 to 90 °C
- Humidity: 0 to 100% RH, non-condensing
- Shock: 100 g peak (5 drops, 3 axis)
- Operating Pressure: 25 psi

SPECIFICATIONS

Test Conditions: $V_{in}=10\pm 0.01V_{DC}$, $T_a=25^{\circ}C$. Relative Humidity: $40\% < RH < 60\%$

| SPECIFICATIONS | MIN | TYP | MAX | UNIT | CONDITIONS |
|---------------------------------|--|-----|------|---------|-----------------|
| PMF2101 | 0 | | 200 | sccm | |
| PMF2102 | 0 | | 1000 | sccm | |
| PMF2103 | 0 | | 2000 | sccm | |
| PMF2104 | 0 | | 3000 | sccm | |
| PMF2105 | 0 | | 4000 | sccm | |
| PMF2108 | 0 | | 10 | SLM | |
| Output Voltage (V) ² | 1 to 5 | | | VDC | |
| Null Voltage (V) | 0.95 | 1 | 1.05 | VDC | |
| Output Count (D) | 256 to 16124 | | | Count | |
| Null Count (D) | 156 | | 356 | Count | |
| Null Drift | | | 0.2 | % F.S. | Per year |
| Repeatability | | 0.1 | | % F.S. | |
| Accuracy ³ | | 1% | | F.S. | 0 to 25% F.S. |
| | | 4% | | Reading | 25 to 100% F.S. |
| Resolution (D) | | 14 | | Bit | |
| Response Time ⁴ | | 5 | | mSec | |
| Supply Voltage (V) | 6 | 10 | 16 | Vdc | 10V recommended |
| Supply Voltage (D) | 4.75 | 10 | 16 | Vdc | 10V recommended |
| Current | | 21 | 26 | mA | |
| Wetted Materials | Silicon carbide, epoxy, PPE+PE, FR4, and silicone as static seal | | | | |

1. SLM: standard liter per minute. Standard conditions: 0 °C and 1 atmosphere.
2. V refers to the analog version of PMF2000, and D refers to the digital I2C version.
3. Maximum deviation in output from nominal over the entire calibrated flow range and temperature range. Errors include offset, full scale span, linearity, flow hysteresis, repeatability and temperature effects over the compensated temperature range.
4. 10% to 90% rise time of the flow sensor to electrically respond to any mass flow change. May be affected by the pneumatic interface.

OUTPUT DESCRIPTION

For **PMF2000V**

Flow Rate = $[(V_{out} - 1 V) / 4 V] \times \text{Full Scale Flow Rate}$

For example, for PMF2101V full scale flow rate is 200 sccm. When Vout reads 3 V, the Flow Rate is: $[(3 V - 1 V) / 4 V \times 200 \text{ sccm}] = 100 \text{ sccm}$

For **PMF2000D**

Flow Rate = $[(\text{Count} - 256) / 15868] \times \text{Full Scale Flow Rate}$

For example, for PMF2101D full scale rate is 200 sccm. When digital output reads 10000, the Flow Rate is:

$[(10000 - 256) / 15868 \times 200 \text{ sccm}] = 122.81 \text{ sccm}$

*Contact Posifa for I²C communication app note

PACKAGE DIMENSIONS

PMF2000V

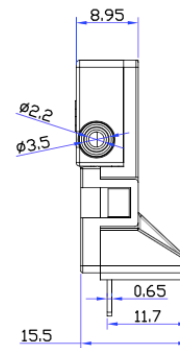
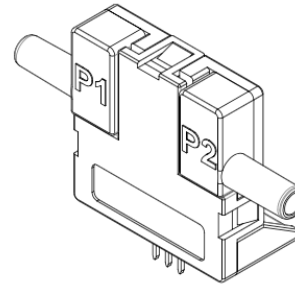
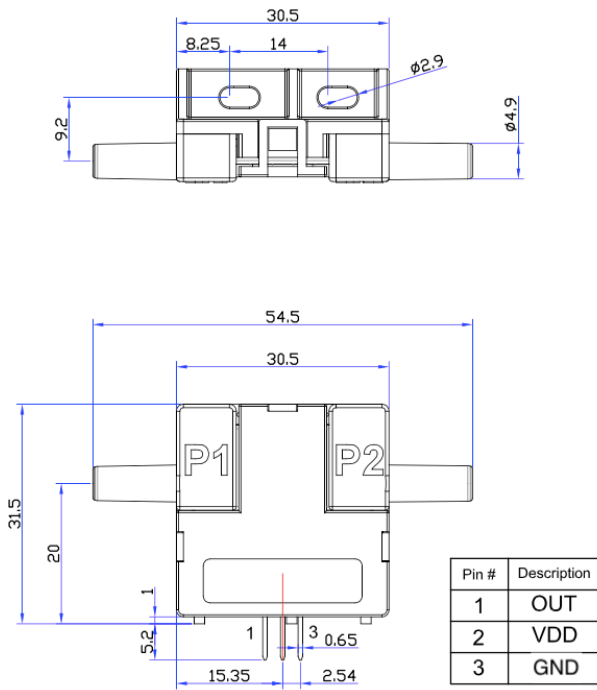

Unit: mm

PMF2000D

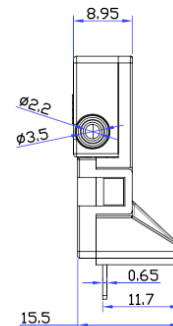
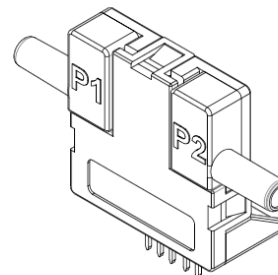
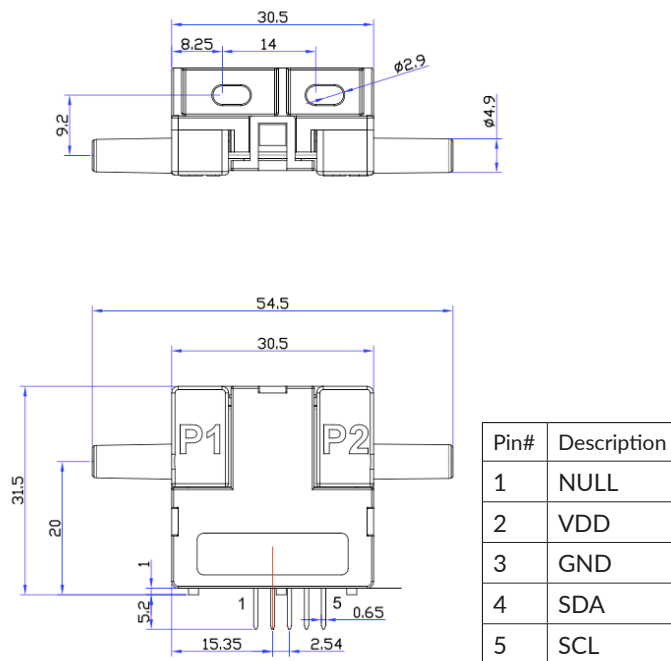

Please contact Posifa for sensor CAD model

ORDERING INFORMATION

| PART NUMBER | SPECIFICATIONS |
|-------------|-----------------------------|
| PMF2101V | 200 sccm, 1 to 5 V, Linear |
| PMF2102V | 1000 sccm, 1 to 5 V, Linear |
| PMF2103V | 2000 sccm, 1 to 5 V, Linear |
| PMF2104V | 3000 sccm, 1 to 5 V, Linear |
| PMF2105V | 4000 sccm, 1 to 5V, Linear |
| PMF2108V | 10 SLM, 1 to 5 V, Linear |

Order I²C Digital Output models by specifying "D" instead of "V" in part numbers above. Please contact Posifa or your local distributor to place an order.

EUROPEAN DISTRIBUTOR

BS-rep GmbH
Eichertstr. 68, D-56745 Weibern, Germany
Tel: +49 (0) 2655 / 96 26 476
Email: info@sensor-rep.de

CUSTOMIZATION OPTIONS

If the standard product described in this datasheet does not completely meet your needs, please contact Posifa Technologies to discuss other options. Help us understand your application and sensor requirements and we can work together to find the best overall solution.